

Modeling



Chapter 8
Intro. to Computer Graphics
Spring 2009, Y. G. Shin



■ Components for Image Synthesis

- Scene description
- Light source
- Viewpoint
- Scene = an assembly of one or more models
 - A model contains
 - structural description - geometry of the shape
 - surface description - appearance (lighting)
 - For a simulation model we need more
 - physics
 - mechanics - assemblability, reachability

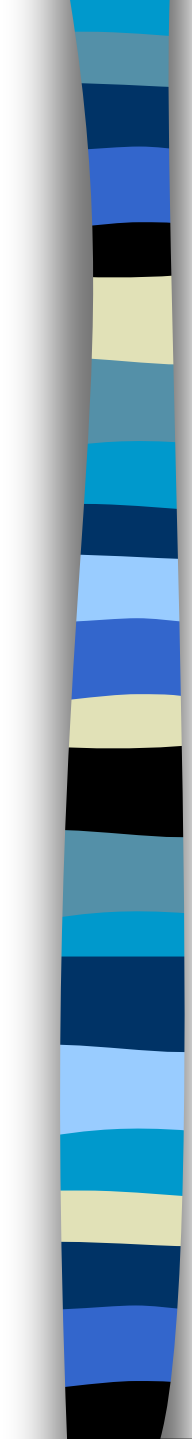
- 
- How are models used?
 - Image synthesis
 - Design
 - Manufacturing - part relationships, feasibility
 - Simulation
 - Art
 - Levels of Detail
 - visual detail vs. structural detail
 - more detail = more realism/accuracy
= more resources
 - procedural objects : more detail when
you need it.



■ Issues in Model Selection

- Computational cost of the model
 - storage space
 - object construction time
 - display time
- Effectiveness in modeling the desired phenomena
 - geometry
 - looks good for image-making
 - accuracy for simulation
 - appearance
 - looks
 - accuracy

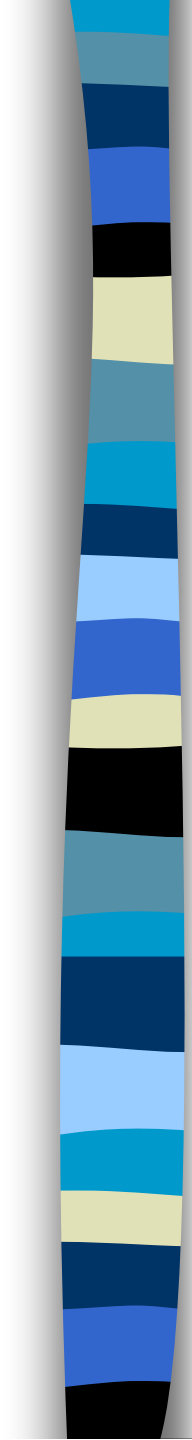
- 
- Implementation Complexity
 - the number of primitives
 - the number of shapes
 - complexity of each instance
 - The methods need to acquire (or create) data
 - Ease of simulation
 - match to simulator
 - cost of conversion
 - Ease of animation
 - physics of motion
 - constraints



- The difference between models and rendering

- Models describe the object and its attributes:
 - shape or geometry
 - reflectivity, transmittance
 - surface smoothness, color
 - texture
- Rendering algorithm transforms the model to a screen-based view from a given:
 - COP or camera position, location, view direction, view up direction projection type, window clipping plane, focal length
 - One or more light sources – location, direction, intensity, color
 - Atmospheric effects - ambient light, fog, depth cuing
 - Image quality parameters – antialiasing, resolution



Operations on models

- Transformations

- Change of detail

 - Interpolation to augment detail

 - Averaging to reduce detail

 - Hierarchy of models of the same object at different levels of detail

- Measurement

 - topology - connectivity, feature distance

 - volume

 - surface tangent

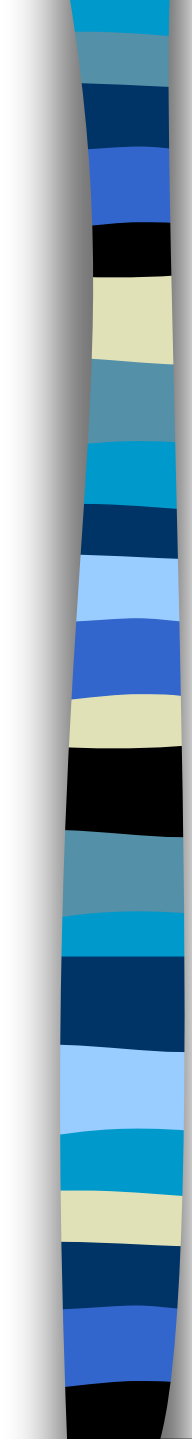
- 
- Combination
 - union
 - intersection
 - difference
 - cut/slice
 - Deformation
 - skew
 - stretch
 - bend
 - perturb (e.g., randomly, stochastically, or fractally)
 - Display operation
 - wire-frame
 - visible line/surface
 - ray cast
 - radiosity

- Model Classification

- Graphical Model : represent geometric information in terms of points and lines.
- Surface Model : planar surface
- Volume Model : voxels

- Wireframes

- CAD systems
- Simple BUT ambiguous

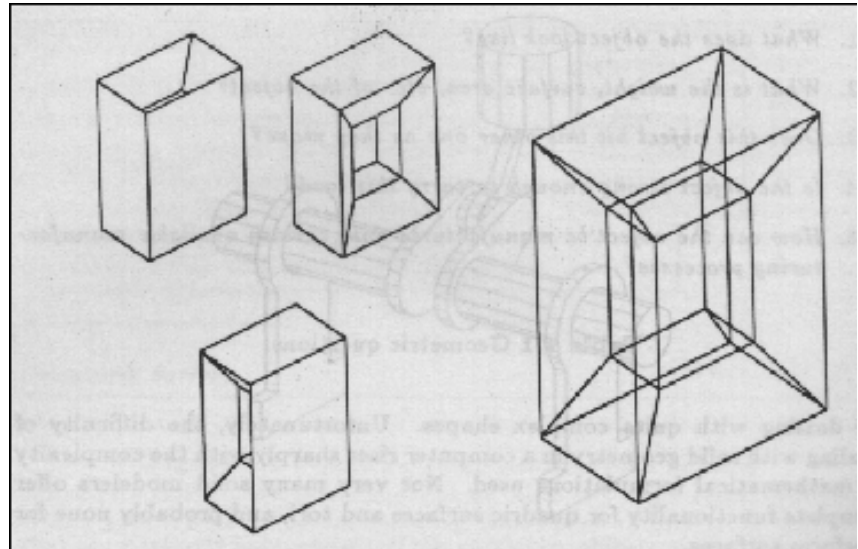



◆ Surface and Boundary Models

■ Points

- List of coordinate triples (a collection of 3D points)
- Require a fairly dense distribution of points for accurate modeling

■ Polygon mesh (Boundary representation)

- Vertex, edge, face structure
- Relatively simple to define, manipulate, and display
- Commonly used - good for flat surfaces



- Curved surfaces

- Parametric functions of two variables
- True mathematical curvature
- Adjacent patches may be constrained for continuity
- Shape derived from control points and/or tangent vectors
- Approximating and interpolating
- Bezier, Hermite, Bicubic, B-spline, NURBS

■ Implicit surfaces / Algebraic equations

- The surfaces are defined as the solutions to algebraic formulas.

■ Quadric surfaces

- Implicit second-order polynomial equations

- Double cones

$$\frac{x^2}{a^2} + \frac{y^2}{b^2} - \frac{z^2}{c^2} = 0$$

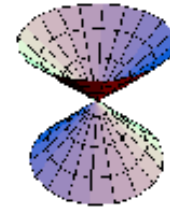

- Ellipsoids

$$\frac{x^2}{a^2} + \frac{y^2}{b^2} + \frac{z^2}{c^2} = 1$$



- Hyperboloids of one sheet

$$\frac{x^2}{a^2} + \frac{y^2}{b^2} - \frac{z^2}{c^2} = 1$$

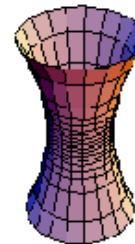

- Hyperboloids of two sheets

$$\frac{z^2}{c^2} - \frac{x^2}{a^2} - \frac{y^2}{b^2} = 1$$

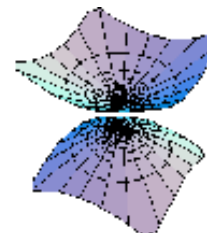

◆ Volume and CSG Models

- Voxels (Spatial-occupancy enumeration)
 - Use identical cells
 - Space-filling tessellation with cubes or parallelepipeds
 - Density or value associated with each voxel
 - Expensive storage but simple data structure
 - Useful for medical imaging – volume visualization
 - Special techniques needed to compute surface normals and shading

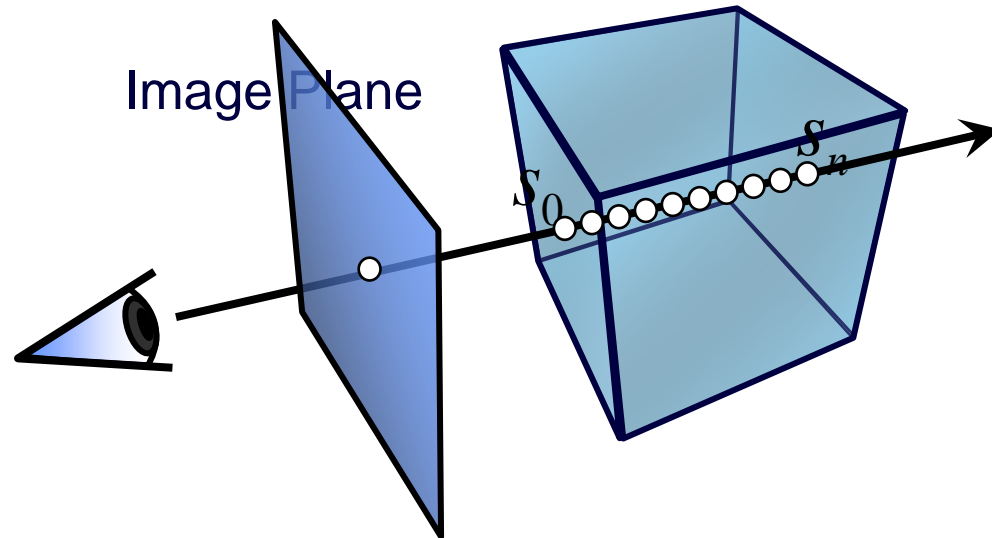

■ Octree

- Space subdivision
- Partition space into 8 cubes, recursively
- Increases space efficiency of solid tessellations
- Primarily an indexing scheme for access efficiency

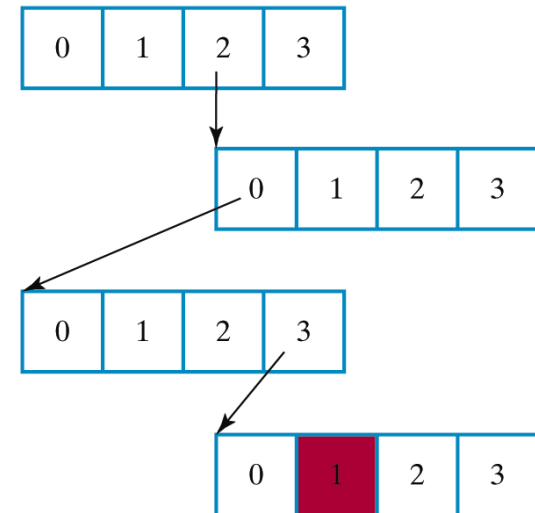
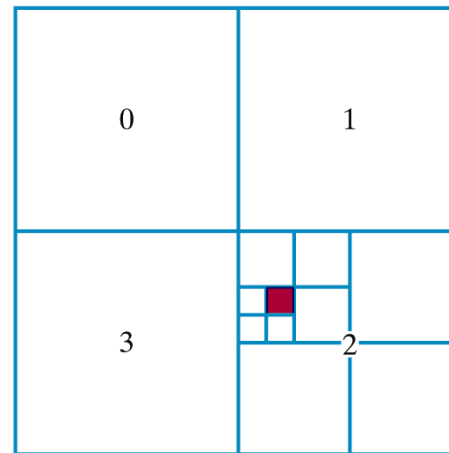
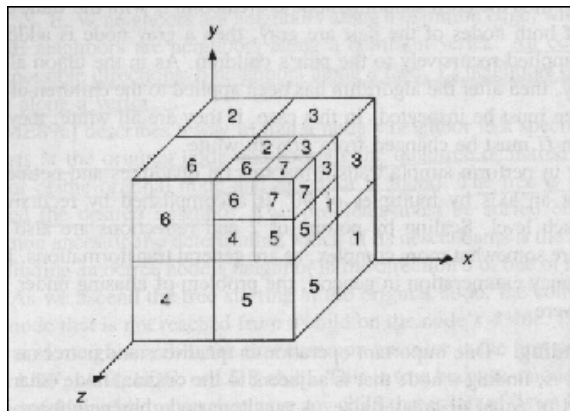
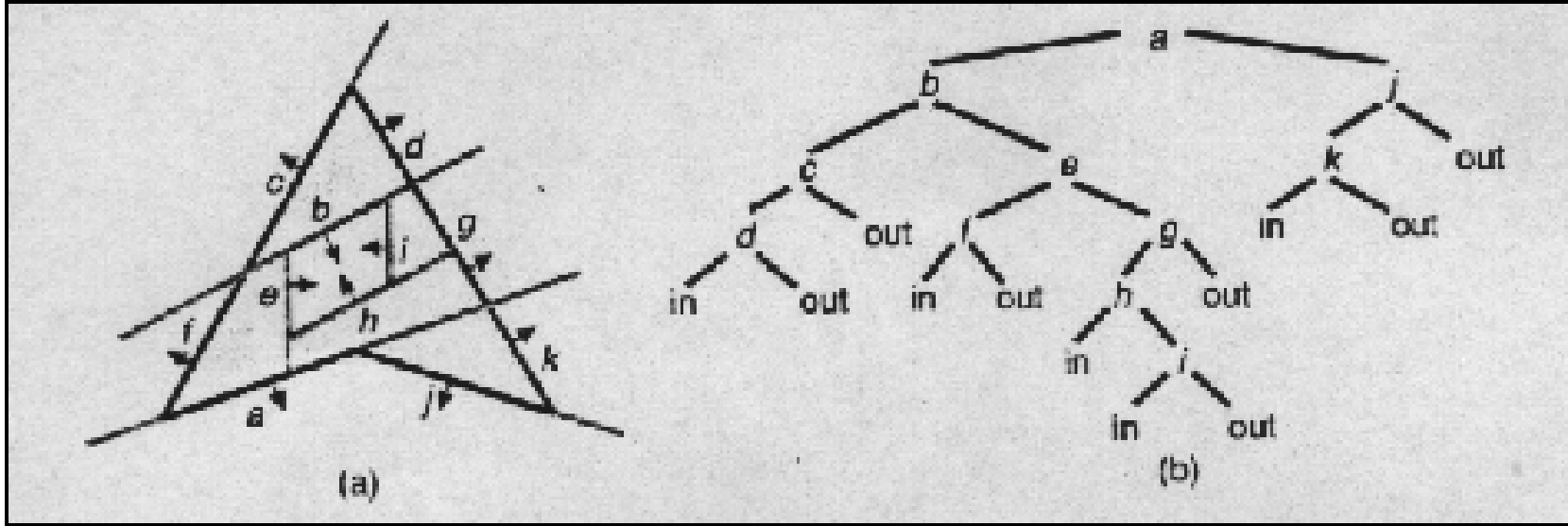

Figure 8-65

Quadtree representation for a square region of the xy plane that contains a single foreground-color area on a solid-color background.

- Binary space partitioning (BSP) tree

- Subdivide a scene into two sections at each step with a plane that can be at any position and orientation
- Smaller tree size than octrees



■ CSG (Constructive Solid Geometry)

- Recursively combine simple primitives by boolean operations
- Simple primitives

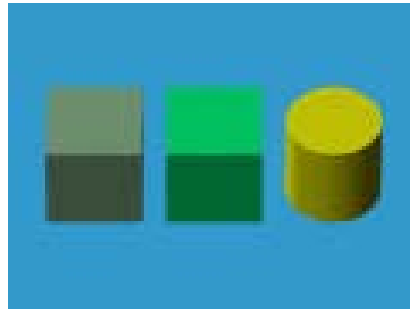
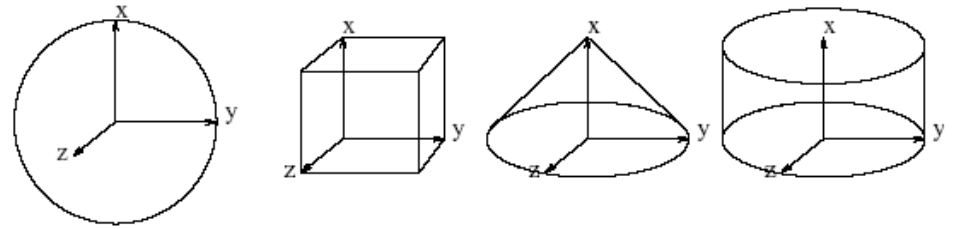

Primitives

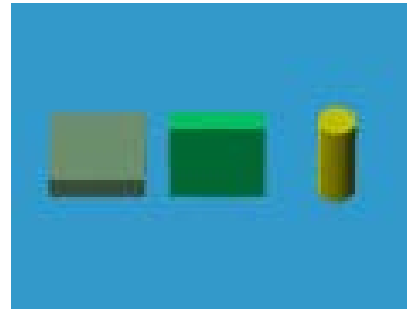

Transformed

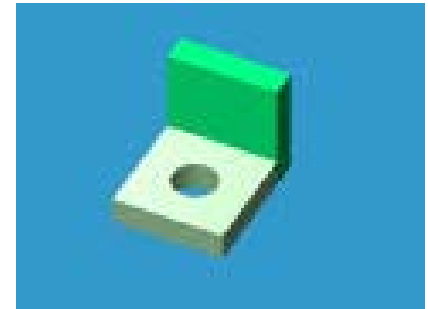

Combined

Tree structure

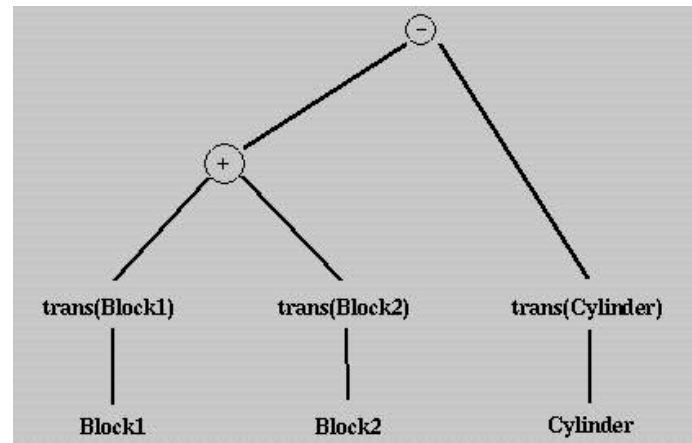

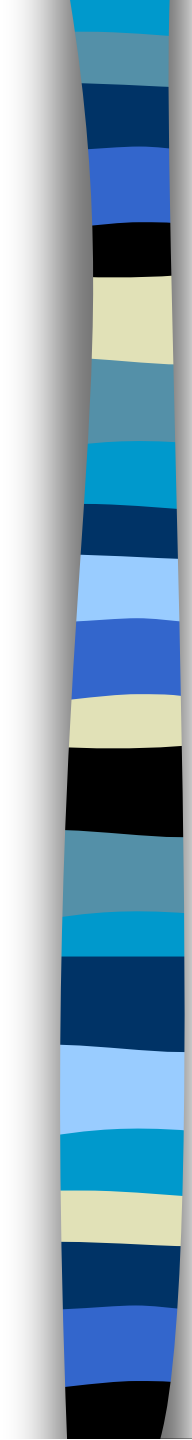
- 
- Specialized (single primitive) systems
 - Ellipsoids
 - Model elongated, symmetric, rounded objects
 - Cylinders
 - Model elongated, rounded objects
 - Spheres
 - Isotropic primitives
 - Simple geometry
 - Render as shaded spheres or flat disks

■ Potential functions

- Models for blobby objects (e.g., muscles)
- Center-point
- Radius-dependent decreasing value
- Act like energy sources, summing when overlapping
- Smooth interfaces between primitives
e.g., smooth model
: combination of Gaussian density functions

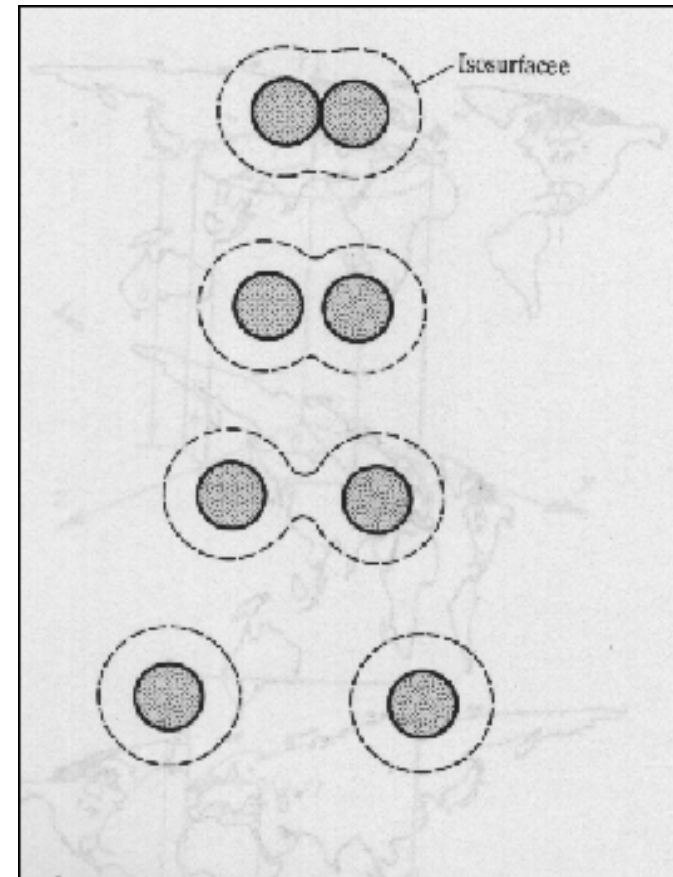

File Execute Windows Connection Options Help

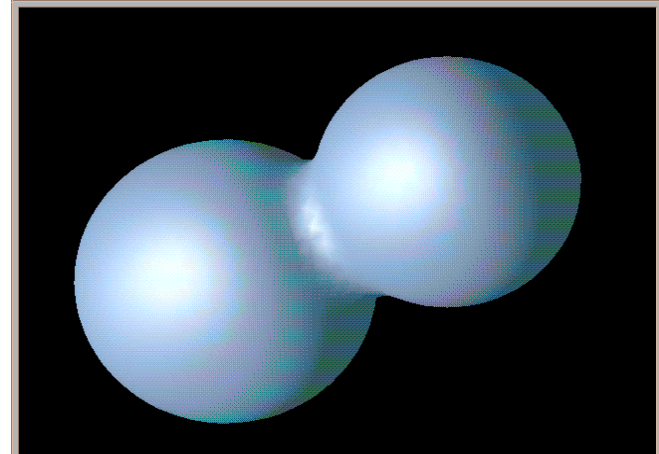

■ Particle systems

- Sets of many points moving in spatial paths.
- Shape description is combined with physical simulation

X (position)

v (velocity)

f (Force accumulator)

m (mass)

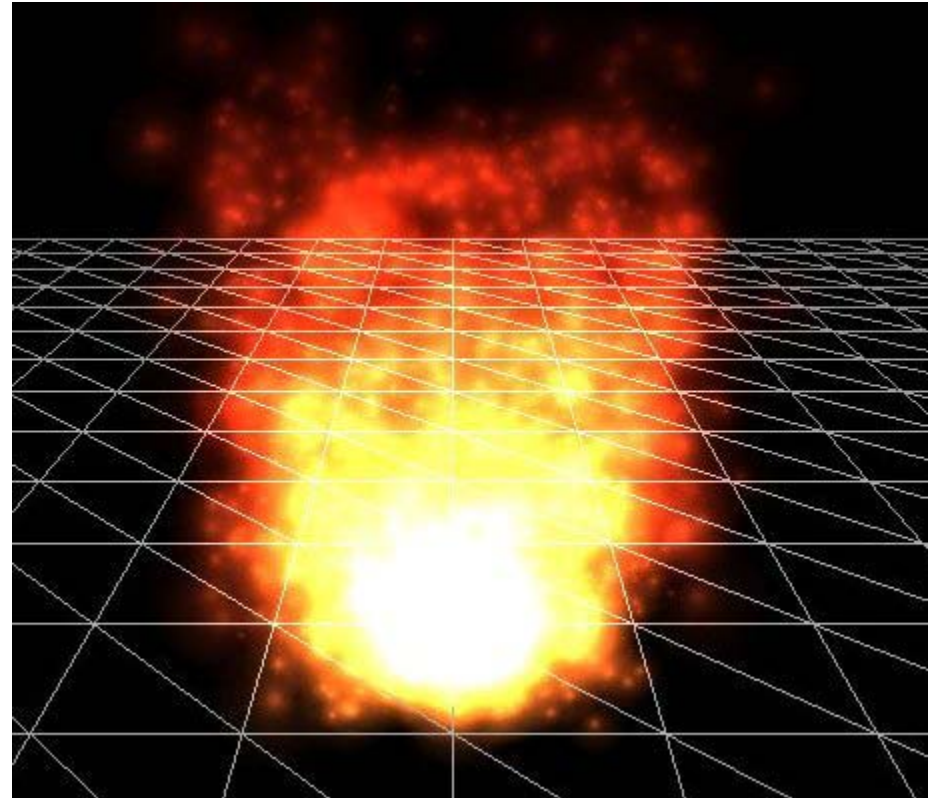



□ Comparison of Representation

▷ accuracy

spatial-partitioning, polygonal b-rep : approximated
CSG with non-polyhedra primitives, curved b-rep :
accurate

tradeoff : resolution and space or time

▷ domain

primitive instancing, sweeps : limited
b-rep : more wide

▷ uniqueness :

octree, spatial-occupancy-enumeration
: unique representation

primitive instancing : does not guarantee uniqueness



▷ validity

b-rep : most difficult to validate

BSP tree : represent valid spatial set

CSG tree : needs local syntactic checking

▷ closure

simple sweep : not closed under Boolean operation

b-rep : hard to maintain closure after Boolean
operation of non 2-manifolds

▷ compactness and efficiency

octree, BSP-tree, CGS : unevaluated model

b-rep, spatial occupancy enumeration : evaluated
model

◆ Fractals

- Birth of **fractal geometry**: Benoit B. Mandelbrot (IBM) published his seminal book "The Fractal Geometry of Nature" in 1977.
- the geometry best describing most natural objects is not traditional 3D Euclidian geometry, but rather what Mandelbrot describes as the *fractal geometry of nature*.

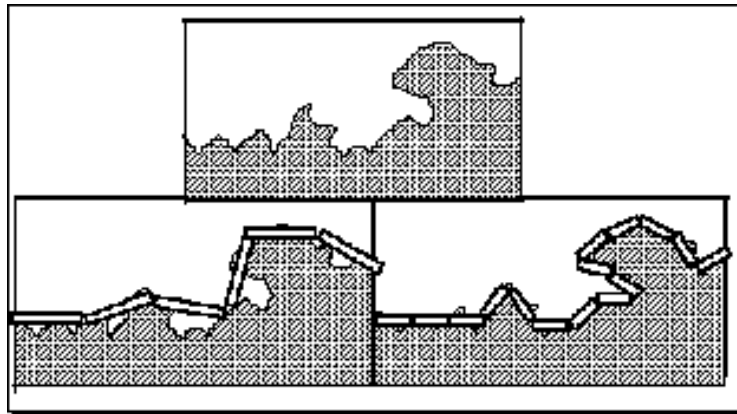

How long is the coast of Britain?"

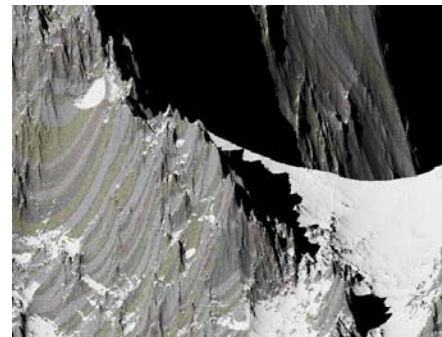
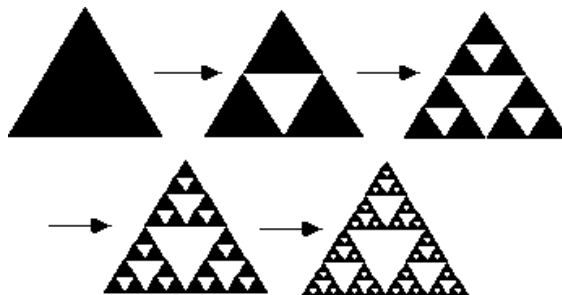

■ Properties of Fractals

- Self-similarity or statistical self-similarity
- Shapes repeat themselves exactly at different scales
- Simple algorithms but complex results
- Iterative procedure
- Noninteger dimension

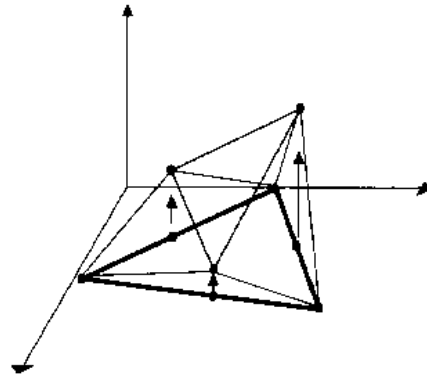
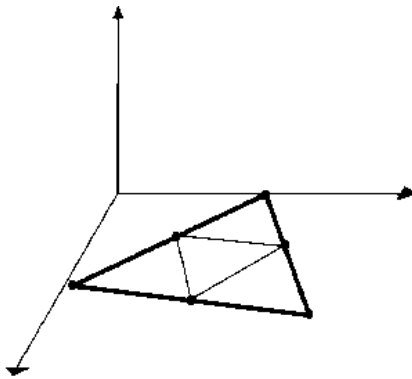

Generating Mountains



Mandelbrot zoom
(from Wikipedia)

■ Fractal Dimension

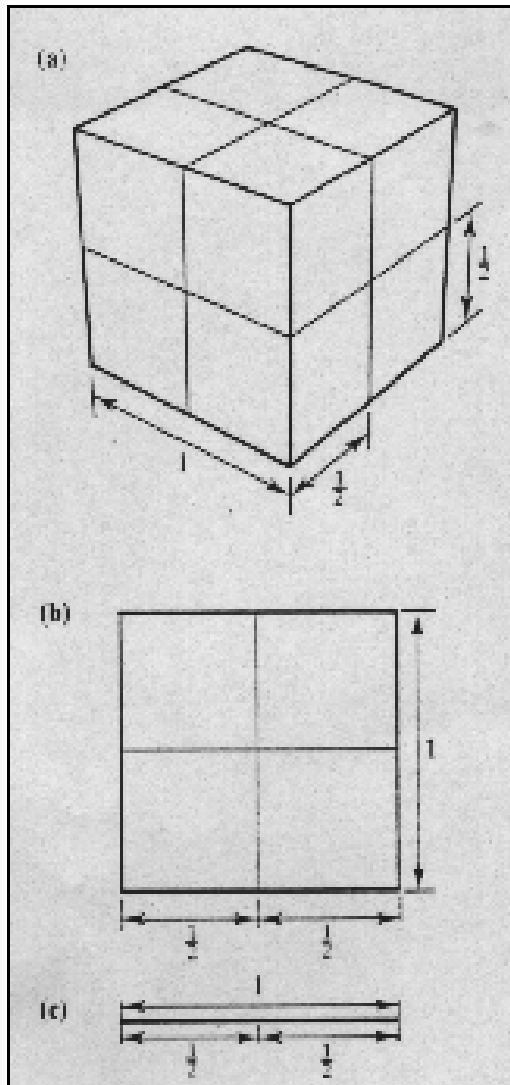

Dimension (D)	Self-similar parts (N)	Scaling factor (S)
1	2	1/2
2	4	1/2
3	8	1/2

$$N = 1/S^D$$

$$D = \log(N) / \log(1/S)$$

- Cantor set



$$\frac{\log 2}{\log 3} = 0.6309\dots$$

We have an object with dimensionality less than one, between a point (dimensionality of zero) and a line (dimensionality 1)

- Koch curve

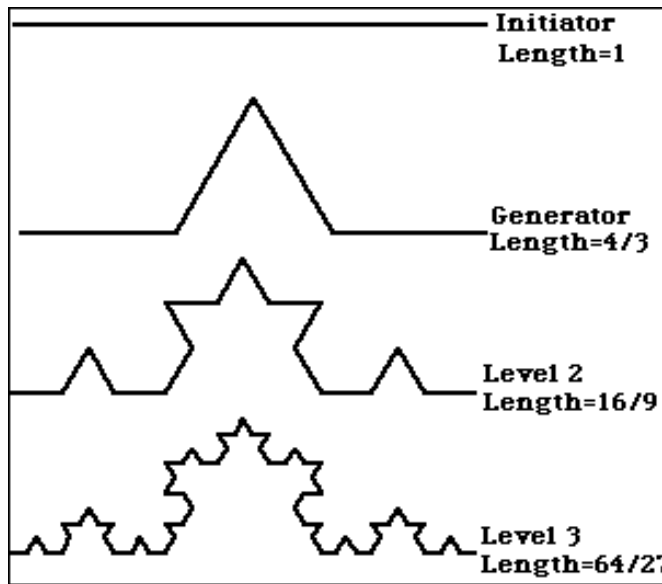

$$S = 1/3, \quad N = 4$$

$$\Rightarrow D = \log(4)/\log(3)$$

$$= 1.2619\dots$$

▷ Classification of Fractals

□ Deterministic Fractals

: the algorithm produce an identical structure each time it is run.

[Algorithms]

- Linear replacement mapping
 - statistically self-similar
 - snowflake, tree
- Iterated function system
 - self-affine fractals
 - use contractive affine transformation
 - terrain, water, cloud
- Complex plane mapping
 - Julia, Mandelbrot sets

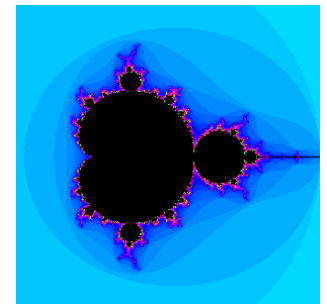
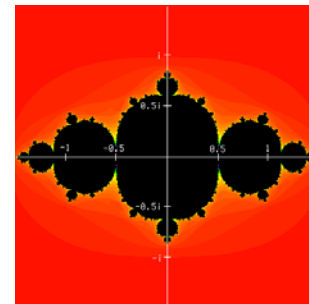
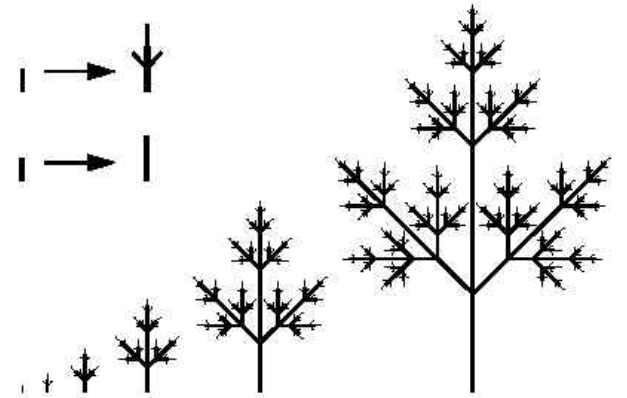

Mandelbrot set

The Mandelbrot set M is defined by a family of complex quadratic polynomials given by

$$f_c(z) = z^2 + c$$

where c is a complex.

For each c , one considers the behavior of the sequence:

$$(f_c(0), f_c(f_c(0)), f_c(f_c(f_c(0))), \dots)$$

The Mandelbrot set is defined as the set of all points c such that the above sequence does not escape to infinity.

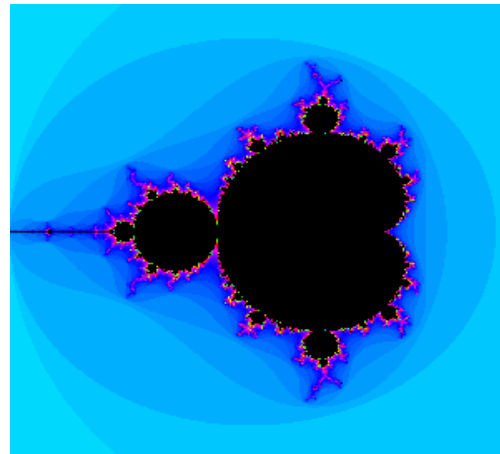
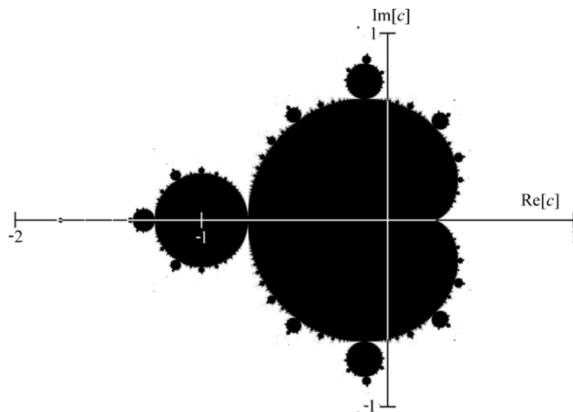

□ Stochastic Fractals

: the random processes play a central role in determining the structure of the fractal object

[Algorithms]

Stochastic processes - mountain landscapes

